

101308
55mm Outer Frame
Steel U Channel 113410
Steel Box 113421

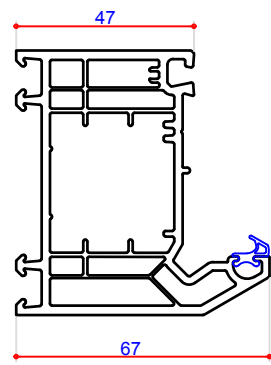

101309
67mm Outer Frame
Steel U Channel 113410
Steel P Section 113418
Steel Box 113422

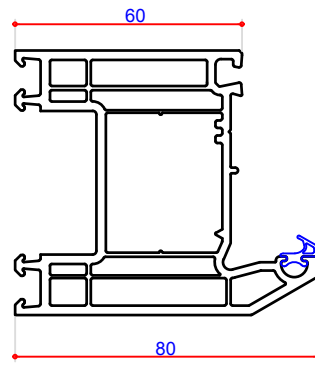

105176
80mm Outer Frame
Steel Box 713191
Aluminium Box 115115
Steel P Section 113418

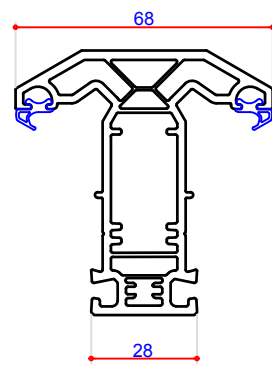

102297
68mm T Mullion
Steel Box 113412
Aluminium Box 115114

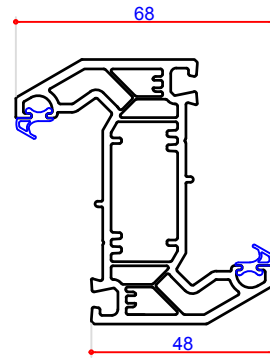

102298
68mm Z Mullion
Steel Box 113412
Aluminium Box 115114

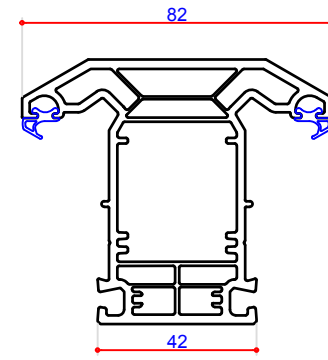

102299
82mm T Mullion
Steel Box (1.2 & 3mm) 113415
Steel P Section 113416
Aluminium Box 115115

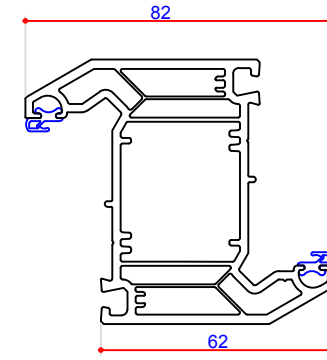

102296
82mm Z Mullion
Steel Box (1.2 & 3mm) 113415
Steel P Section 113416

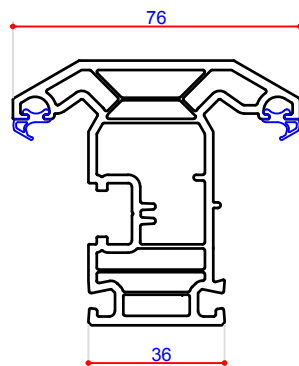

103365
76mm Casement Sash/T Mullion
Steel P Section 113411
Steel P Section 113423*
(*available pre prepped)

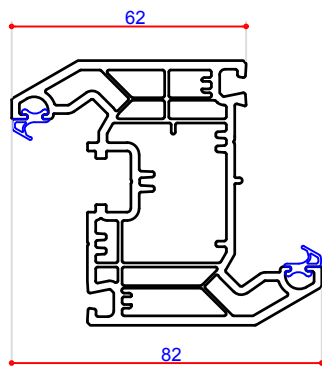

103364
82mm Tilt N Turn Sash/Z Mullion
Steel U Channel 113413
Steel P Section 113417

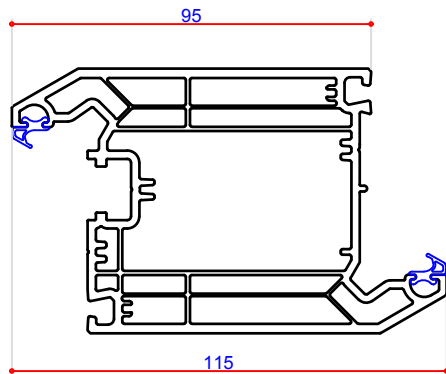

103366
115mm Open In Door Sash/Z Midrail
Steel U Channel 113414
Prepped Steel U 113414.500000
Steel Box 113424

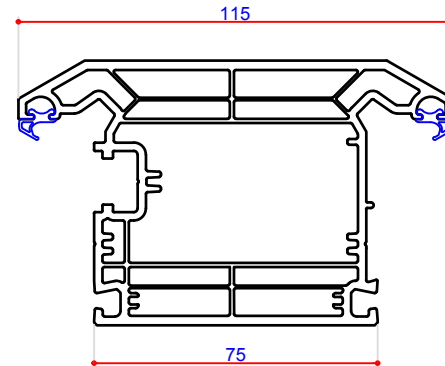

103367
115mm Open Out Door Sash/T Midrail
Steel U Channel 113414
Prepped Steel U 113414.500000
Ali Box 115116
Steel Box 113424

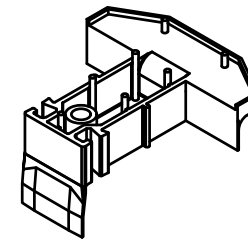

109057
End Cap Moulding
for 102297



104396
French Door Mullion
Adapter (For 102297)



104397
French Casement Mullion
Adapter (For 102297)

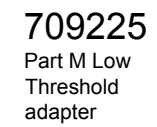

709225
Part M Low
Threshold
adapter

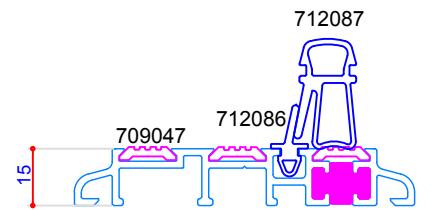

704289 Part M Low Threshold

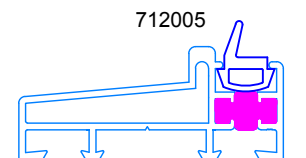

704092 Standard Low Threshold

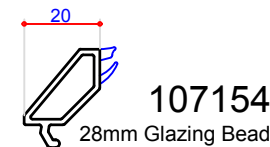

107154
28mm Glazing Bead

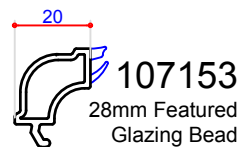

107153
28mm Featured
Glazing Bead

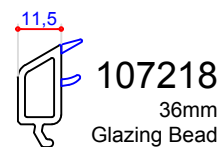

107218
36mm
Glazing Bead

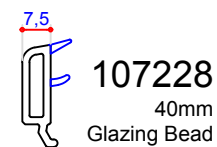

107228
40mm
Glazing Bead



107156
44mm Glazing
Bead (no gasket)
2.5mm Gasket 112135



3.5mm Repair
Gasket 112279



115114
36x11 Mech Joint
Aluminium Box

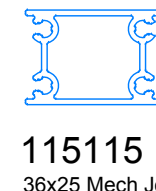

115115
36x25 Mech Joint
Aluminium Box

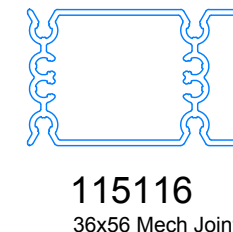

115116
36x56 Mech Joint
Aluminium Box



113410
36x7.5 Steel
U Channel



113413
36x23.5 Steel
U Channel



113412
36x11 Steel
Box



113421
32x17 Steel
Box



113422
32x29 Steel
Box



713191
35x28 Steel
Box



113415
36x25 Steel Box
(1.2mm & 3mm)



113424
35x48 Steel
Box

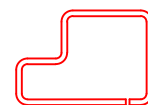

113416
36x25 Steel
P Section



113418
32x25 Steel
P Section

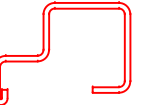

113417
32x24 Steel
P Section

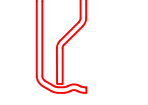

113411
28x13 Steel
P Section



113423
28x31 Steel
P Section

*Also available in
prepped lengths
475mm
113423.000001
775mm
113423.000002
1075mm
113423.000003
1150mm
113423.000005
1200mm
113423.900006

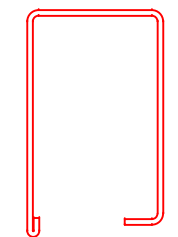

113414
36x60 Steel U Channel
Prepped 113414.500000

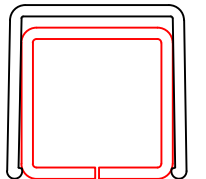

113128
40x40 Steel
Box



709192
Drip Bar
End Cap 709223



709149
Drip Bar
End Cap 709220



709317
Drip Bar
End Cap 709232



744163
Fixing Nipple

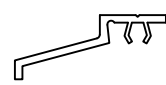

109230
Snap-on Head Drip



109045
Eurogroove Infill



105173
Universal Frame Infill

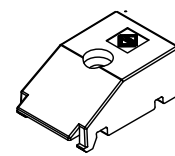



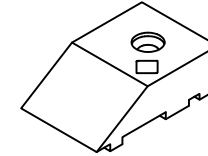







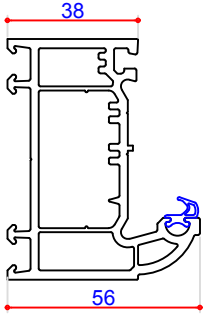
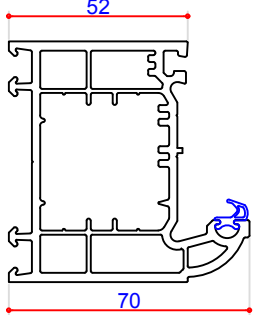
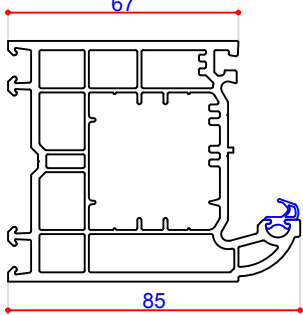
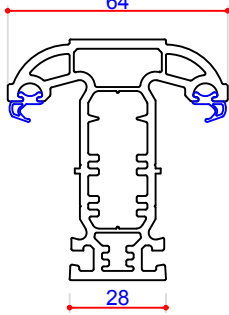
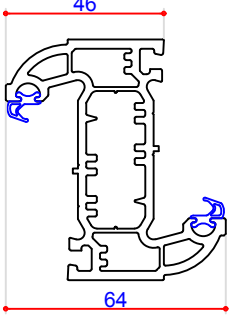
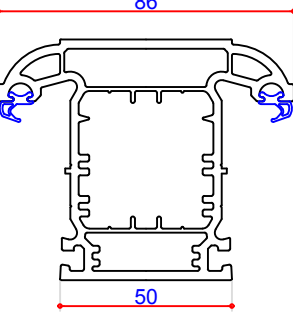
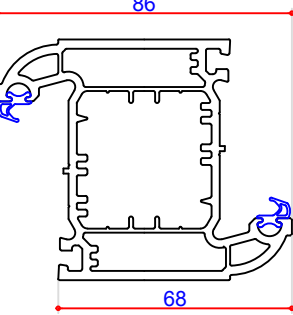
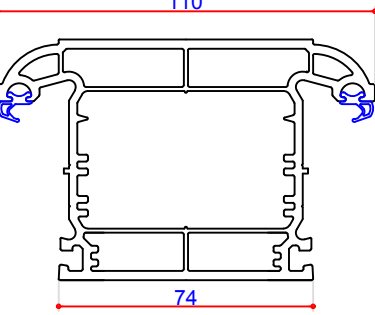
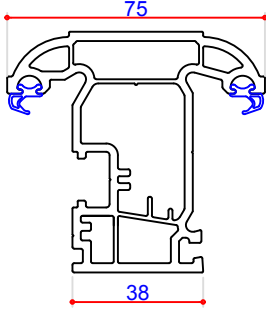
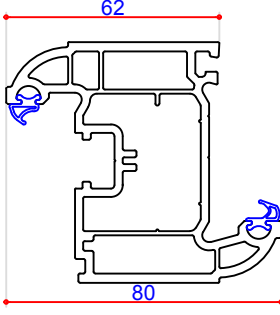
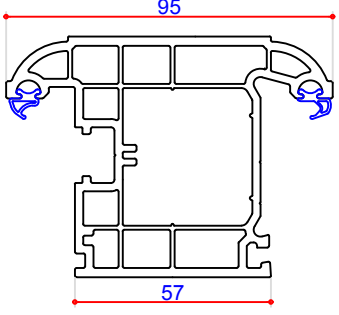
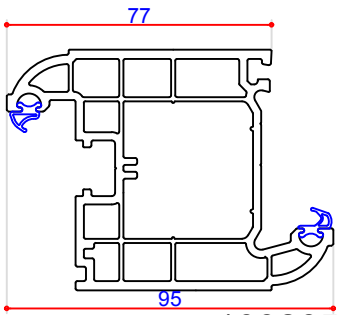
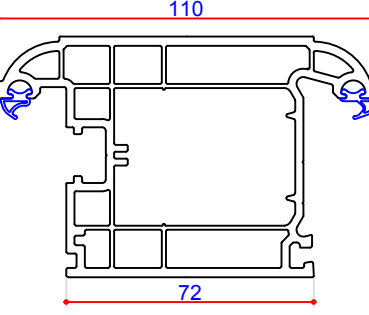
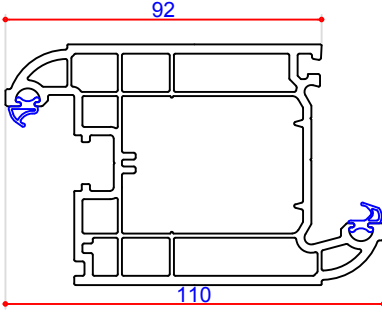
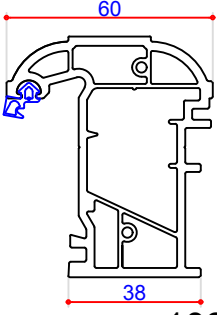
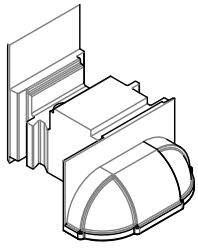
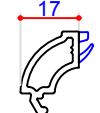
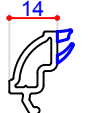
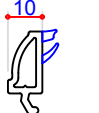

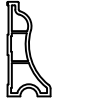







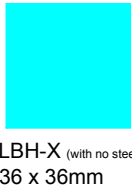
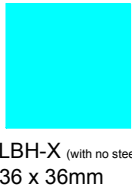
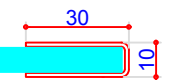

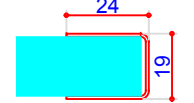

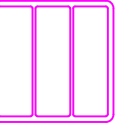
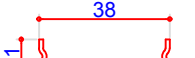



109056
Casement Rider Block
(17-18mm Stack)

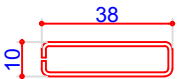
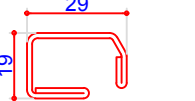
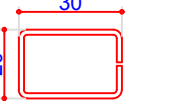
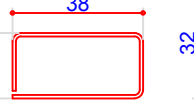
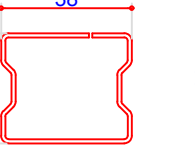
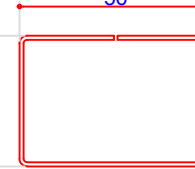
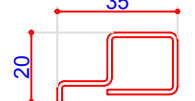
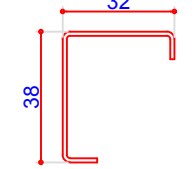
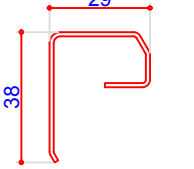
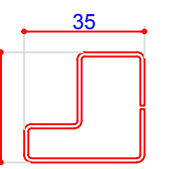

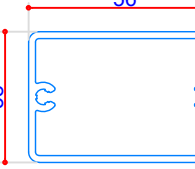

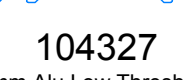

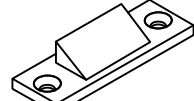
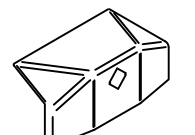
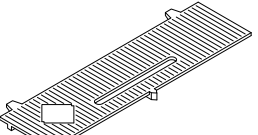
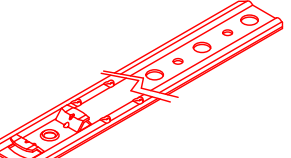
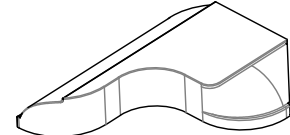
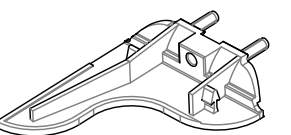
109398
Door & Tilt N Turn
Rider Block

KEY:
PVC Profile
Gasket
Steel
Aluminium

DO NOT SCALE the drawings shown are visual representations only. VEKA PLC has the right to alter the designs, specification & descriptions without prior notice as part of our policy of continuous development and improvements.

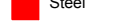
 <p>56mm Outer Frame 101160 Steel Box 113245 Steel U Channel 113317 LBH-X 36x17 & Steel U 113385 Thermal Insert 146200</p>	 <p>70mm Outer Frame 101161 Steel Box 113378 Steel U Channel 113321 Steel P Section 113371 Aluminium Mech Joint 115108 LBH-X 36x36 (with no steel)</p>	 <p>85mm Outer Frame 101162 Steel Box 113378 Steel U Channel 113321 Steel P Section 113371 Aluminium Mech Joint 115108 LBH-X 36x36 (with no steel)</p>	 <p>64mm T Mullion 102261 Steel Box 113041 Steel U Channel 113321 Alu Mech Joint Bar 115284 LBH-X & Steel U 113386 LBH-X 38 x 10(with no steel)</p>	 <p>64mm Z Mullion 102260 Steel Box 113041 Steel U Channel 113321 Alu Mech Joint Bar 115284 LBH-X & Steel U 113386 LBH-X 38 x 10(with no steel)</p>	 <p>86mm T Mullion 102263 Steel Box 113378 Steel P Section 113371 Aluminium Mech Joint 115108 Steel Box 113041</p>	 <p>86mm Z Mullion 102262 Steel Box 113378 Steel P Section 113371 Aluminium Mech Joint 115108 Steel Box 113041</p>	 <p>110mm Midrail 102264 Steel Box 113376 Alu Mech Joint 115286</p>								
 <p>75mm Casement Sash 103264 Steel Box 113039 Steel U & LBH-X 15x25 113387 Steel P Section 113372</p>	 <p>80mm Tilt & Turn Sash 103267 Steel P Section 113373 LBH-X 8.5 x 32.5 with no steel</p>	 <p>95mm T Door Sash 103266 U Channel 113375 Prepared U Channel 113374</p>	 <p>95mm Z Door Sash 103265 U Channel 113375 Prepared U Channel 113374</p>	 <p>110mm T Door Sash 105169 U Channel 113320 Prepared U Channel 113318</p>	 <p>110mm Z Door Sash 105168 U Channel 113320 Prepared U Channel 113318</p>	 <p>60mm False Mullion 102265 Steel P Section 113316 Steel Box 113019 Gasket 112263</p>	 <p>False Mullion End Cap Moulding 109525 LH/RH (for 102265)</p>								
 <p>28mm Bead 107155</p>	 <p>32mm Bead 107162</p>	 <p>36mm Bead 107169</p>	 <p>40mm Bead 107156</p>	 <p>Drip Bar 109122 End Cap 109141</p>	 <p>Drip Bar 709192 End Cap 709223</p>	 <p>Drip Bar 109030 End Cap 109140</p>	 <p>Snap-on Head Drip 109230</p>	 <p>Eurogroove Infil 109045</p>	 <p>Universal Frame Infil 105173</p>	 <p>T+T & Door Weather Seal/Repair 112355</p>	 <p>4mm Repair Gasket 112384</p>				
<p>Styrofoam LBH-X Grade - Close Tolerance #Non Veka Part - Available from: Panel Systems Ltd, Units 3-9 Welland Close Parkwood Ind Est, Rutland Road, Sheffield S3 9QY. Tel: 0114 2752881 Fax: 0114 2768807</p>	 <p>LBH-X (with no steel) 10 x 38mm</p>	 <p>LBH-X (with no steel) 8.5 x 32.5mm</p>	 <p>LBH-X (with no steel) 36 x 36mm</p>	 <p>LBH-X 36 x 7mm With Steel U Channel 113386</p>	 <p>LBH-X 15 x 25mm With Steel U Channel 113387</p>	 <p>LBH-X 36 x 17mm With Steel U Channel 113385</p>	 <p>Thermal Insert 146200</p>	 <p>Thermal Insert 143400</p>	 <p>Steel U Channel 113321</p>	 <p>Steel U Channel 113317</p>	 <p>Steel U Channel 113375</p>	 <p>Steel U Channel 113320</p>	 <p>Alu Mech Joint Bar 115108</p>	 <p>15mm Alu Low Thresh Sash Sealing Strip 104225</p>	 <p>Threshold Gasket 112072</p>
 <p>Steel Box 113041</p>	 <p>Steel Box 113039</p>	 <p>Steel Box 113019</p>	 <p>Steel Box 113245</p>	 <p>Steel Box 113378</p>	 <p>Steel Box 113376</p>	 <p>Steel P Section 113316</p>	 <p>Steel L Section 113373</p>	 <p>Steel P Section 113372</p>	 <p>Steel P Section 113371</p>	 <p>Alu Mech Joint Bar 115284</p>	 <p>Alu Mech Joint Bar 115286</p>	 <p>29mm Alu Low Thresh Gasket Carrier 104233</p>	 <p>Threshold Gasket 112112</p>		
 <p>Drainage Cap 109267</p>	 <p>Cavity Locking Wedge 109265</p>	 <p>Cockspur Wedge 109378</p>	 <p>Clip In Packer 109377</p>	 <p>Frame Fixing Bracket 141428 available sizes 175, 200 & 250mm</p>	 <p>Casement Horn Cover Moulding 109549 LH/RH</p>	 <p>Casement Horn Base Moulding 109539 LH/RH</p>	 <p>Threshold Keep Plate 140365</p>								

KEY:
 PVC Profile
 Gasket
 Steel
 Aluminium

DO NOT SCALE the drawings shown are visual representations only. VEKA PLC has the right to alter the designs, specification & descriptions without prior notice as part of our policy of continuous development and improvements.

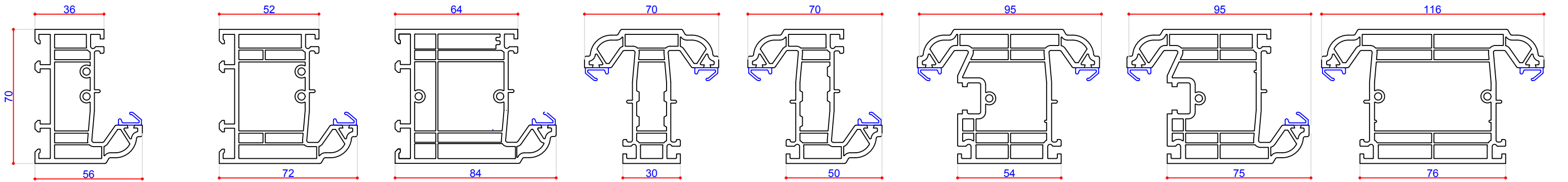

701531 (P10531)
56mm Outer Frame
Steel Box 713155 (S00155)
Steel Box 713187 (S00187)
Steel U Channel 713185 (S00185)
Thermal Insert 709331 (P10331)

701532 (P10532)
72mm Outer Frame
Steel Box 713174 (S00174)
Steel Box 713191 (S00191)
Steel U Channel 713186 (S00186)
Steel P Section 713157 (S00157)
Thermal Insert 709332 (P10332)

701204
84mm Outer Frame
Steel Box 713174 (S00174)
Steel Box 713191 (S00191)
Steel U Channel 713186 (S00186)
Steel P Section 713157 (S00157)
Thermal Insert 709332 (P10332)

702533 (P10533)
70mm T Transom
Steel Box 713187 (S00187)
Steel Box 713155 (S00155)
35 x 12.5 Ported Alu 715161

702536 (P10536)
70mm Z Transom
Steel Box 713187 (S00187)
Steel Box 713155 (S00155)

705543 (P10543)
95mm T Tran/Slim Open Out Door Sash
Steel Box 713158 (S00158)
Steel U Channel 713159 (S00159)
Punched Steel U 713160 (S00160)
35 x 30 Ported Alu 715162

705545 (P10545)
95mm Z Tran/Slim Open In Door Sash
Steel Box 713158 (S00158)
Steel U Channel 713159 (S00159)
Punched Steel U 713160 (S00160)

702535 (P10535)
116mm Midrail
Steel U Channel 713166 (S00166)
35 x 58 Ported Alu 715163

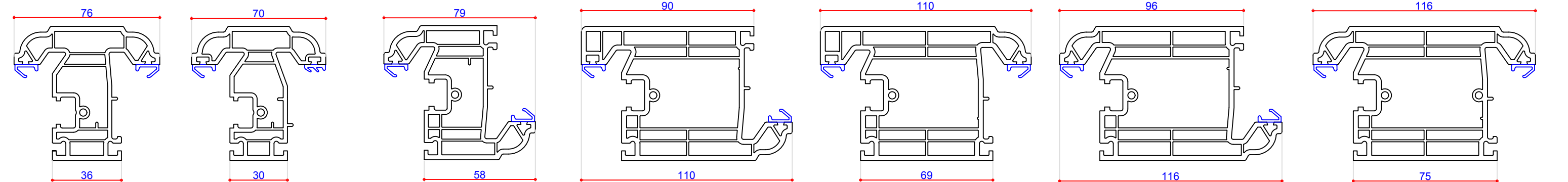

703538 (P10538)
Internally Beaded Sash
Steel P Section 713152 (S00152)

703638 (P10638)
Internally Beaded Sash/Transom
Steel P Section 713183 (S00183)
Steel P Section 713184 (S00184)
13 x 23 Ported Alu 715164

703539 (P10539)
Tilt & Turn Sash
Steel L Section 713161 (S00161)

705540 (P10540)
Door Sash - Open In
Steel U Channel 713162 (S00162)
Punched Steel U 713163 (S00163)

705541 (P10541)
Door Sash - Open Out
Steel U Channel 713162 (S00162)
Punched Steel U 713163 (S00163)

705640 (P10640)
Door Sash - Open In
Steel U Channel 713166 (S00166)
Punched Steel U 713167 (S00167)

705641 (P10641)
Door Sash - Open Out
Steel U Channel 713166 (S00166)
Punched Steel U 713167 (S00167)

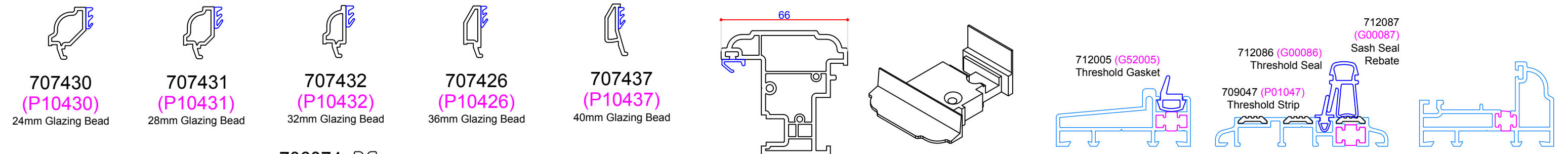

707430 (P10430)
24mm Glazing Bead

707431 (P10431)
28mm Glazing Bead

707432 (P10432)
32mm Glazing Bead

707426 (P10426)
36mm Glazing Bead

707437 (P10437)
40mm Glazing Bead

712005 (G52005)
Threshold Gasket

712086 (G00086)
Threshold Seal

709047 (P01047)
Threshold Strip

712087 (G00087)
Sash Seal Rebate

702612 (P10612)
French Overlap
Steel Box 713135 (S41135)

709211 (M00211)
French Overlap End Cap to suit 702612 (P10612)

704092 (A00092)
Standard Low Threshold

704289 (A00289)
Part M Low Threshold

704333 (A00333)
French Door Low Threshold

715163
35 x 58 Ported Aluminium

715162
35 x 30 Ported Aluminium

715161
35 x 12.5 Ported Aluminium

715164
13 x 23 Ported Aluminium

709331 (P10331)
Thermal Insert

709332 (P10332)
Thermal Insert

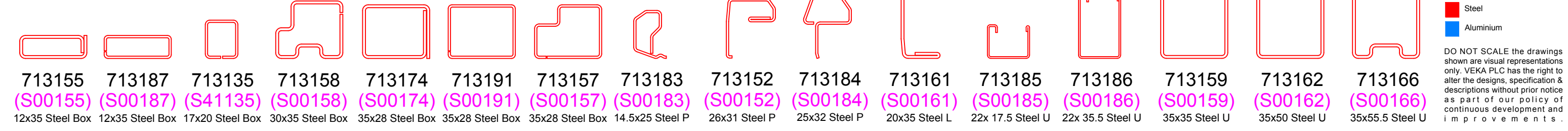

713155 (S00155) 12x35 Steel Box

713187 (S00187) 12x35 Steel Box

713135 (S41135) 17x20 Steel Box

713158 (S00158) 30x35 Steel Box

713174 (S00174) 35x28 Steel Box

713191 (S00191) 35x28 Steel Box

713157 (S00157) 35x28 Steel Box

713183 (S00183) 14.5x25 Steel P

713152 (S00152) 26x31 Steel P

713184 (S00184) 25x32 Steel P

713161 (S00161) 20x35 Steel L

713185 (S00185) 22x 17.5 Steel U

713186 (S00186) 22x 35.5 Steel U

713159 (S00159) 35x35 Steel U

713162 (S00162) 35x50 Steel U

713166 (S00166) 35x55.5 Steel U

KEY:
 ■ PVC Profile
 ■ Gasket
 ■ Steel
 ■ Aluminium

DO NOT SCALE the drawings shown are visual representations only. VEKA PLC has the right to alter the designs, specification & descriptions without prior notice as part of our policy of continuous development and improvements.

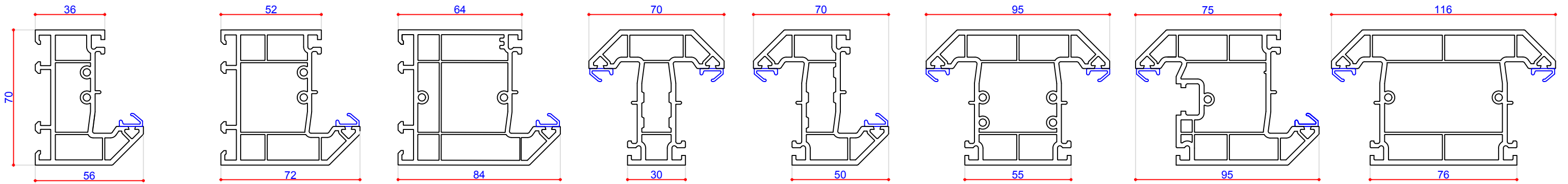

701501 (P10501)
56mm Outer Frame
Steel Box 713155 (S00155)
Steel Box 713187 (S00187)
Steel U Channel 713185 (S00185)
Thermal Insert 709331 (P10331)

701502 (P10502)
72mm Outer Frame
Steel Box 713174 (S00174)
Steel Box 713191 (S00191)
Steel U Channel 713186 (S00186)
Steel P Section 713157 (S00157)
Thermal Insert 709332 (P10332)

701203
84mm Outer Frame
Steel Box 713174 (S00174)
Steel Box 713191 (S00191)
Steel U Channel 713186 (S00186)
Steel P Section 713157 (S00157)
Thermal Insert 709332 (P10332)

702503 (P10503)
70mm T Transom
Steel Box 713187 (S00187)
Steel Box 713155 (S00155)
35 x 12.5 Ported Alu 715161

702506 (P10506)
70mm Z Transom
Steel Box 713187 (S00187)
Steel Box 713155 (S00155)

702504 (P10504)
95mm T Transom
Steel Box 713174 (S00174)
Steel Box 713191 (S00191)
Steel Box 713157 (S00157)

705515 (P10515)
95mm Z Transom
Steel Box 713158 (S00158)

702505 (P10505)
116mm Midrail
Steel U Channel 713166 (S00166)
35 x 58 Ported Alu 715163

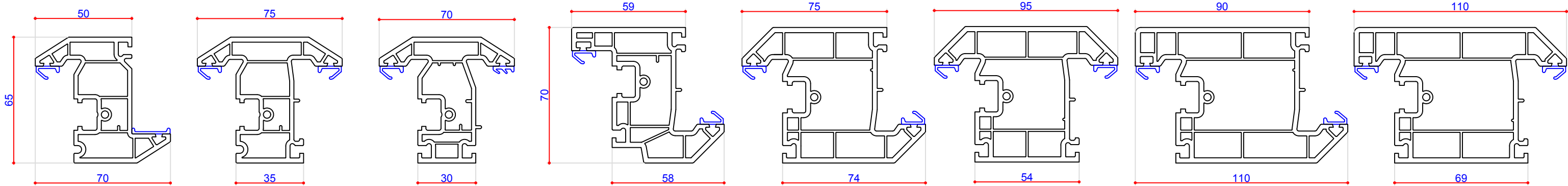

703507 (P10507)
Externally Beaded Sash
Steel P Section 713182 (S00182)

703508 (P10508)
Internally Beaded Sash
Steel P Section 713182 (S00182)

703514 (P10514)
Internally Beaded Sash/Transom
Steel P Section 713183 (S00183)
Steel P Section 713184 (S00184)
13 x 23 Ported Alu 715164

703509 (P10509)
Tilt & Turn Sash
Steel L Section 713161 (S00161)

705515 (P10515)
Slim Door Sash - Open In
Steel U Channel 713159 (S00159)
Punched Steel U 713160 (S00160)

705513 (P10513)
Slim Door Sash - Open Out
Steel U Channel 713159 (S00159)
Punched Steel U 713160 (S00160)
35 x 30 Ported Alu 715162

705510 (P10510)
Door Sash - Open In
Steel U Channel 713162 (S00162)
Punched Steel U 713163 (S00163)

705511 (P10511)
Door Sash - Open Out
Steel U Channel 713162 (S00162)
Punched Steel U 713163 (S00163)

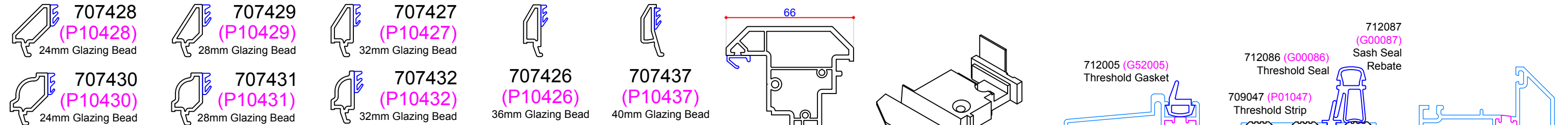

707428 (P10428) 24mm Glazing Bead

707429 (P10429) 28mm Glazing Bead

707427 (P10427) 32mm Glazing Bead

707426 (P10426) 36mm Glazing Bead

707437 (P10437) 40mm Glazing Bead

706074 Mechanical Joint Plug

705807 (P10512) French Overlap
Steel Box 713135 (S41135)

709231 (M00231) French Overlap End Cap to suit 705807 (P10512)

704092 (A00092) Standard Low Threshold

704289 (A00289) Part M Low Threshold

704345 (A00345) French Door Low Threshold

715163 35 x 58 Ported Aluminium

715162 35 x 30 Ported Aluminium

715161 35 x 12.5 Ported Aluminium

715164 13 x 23 Ported Aluminium

709331 (P10331) Thermal Insert

709332 (P10332) Thermal Insert

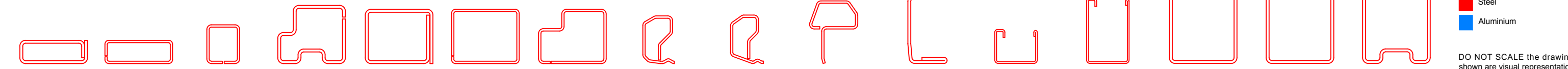

713155 (S00155) 12x35 Steel Box

713187 (S00187) 12x35 Steel Box

713135 (S41135) 17x20 Steel Box

713158 (S00158) 30x35 Steel Box

713174 (S00174) 35x28 Steel Box

713191 (S00191) 35x28 Steel Box

713157 (S00157) 35x28 Steel Box

713182 (S00182) 15x25 Steel P

713183 (S00183) 14.5x25 Steel P

713184 (S00184) 25x32 Steel P

713161 (S00161) 20x35 Steel L

713185 (S00185) 22x17.5 Steel U

713186 (S00186) 22x35.5 Steel U

713159 (S00159) 35x35 Steel U

713162 (S00162) 35x50 Steel U

713166 (S00166) 35x55.5 Steel U

KEY:

- PVC Profile
- Gasket
- Steel
- Aluminium

DO NOT SCALE the drawings shown are visual representations only. VEKA PLC has the right to alter the designs, specification & descriptions without prior notice as part of our policy of continuous development and improvements.